

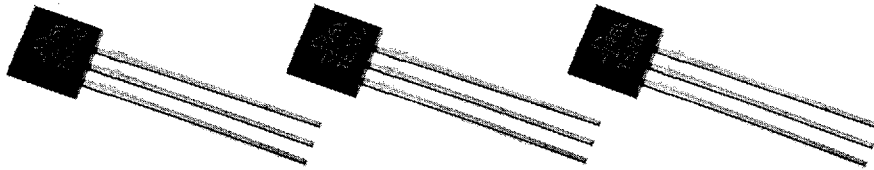

# システムリセット用/ For System Resetting Monolithic IC PST520 Series



本ICはさまざまなCPUシステムやその他のロジックシステムにおいて、電源投入時や電源瞬断時に電源電圧を検出し、確実にシステムにリセットをかける機能を持つICです。

Function of this IC is accurately resetting the system after detecting voltage at the time of switching power on and instantaneous power off in various CPU systems and other logic systems.

### 特長

- (1) 消費電流が少ない。Iccl 55 $\mu$ A Typ. IccH 135 $\mu$ A Typ.
- (2) リセット出力最低保障電圧が低い。0.8V Typ.
- (3) ヒステリシス電圧を設けています。50mV Typ.
- (4) リセット信号発生開始電圧。
 

PST520C	4.5V Typ.
PST520D	4.2V Typ.
PST520E	3.9V Typ.
PST520F	3.6V Typ.
PST520G	3.3V Typ.
PST520H	3.1V Typ.
- (5) テーピングタイプもあります。

### FEATURES

- (1) Current consumption is low. ICCL=55 $\mu$ A Typ. ICCH=135 $\mu$ A Typ.
- (2) Resetting output minimum guarantee voltage is low. 0.8V Typ.
- (3) Hysteresys voltage is provided. 50mV Typ.
- (4) Reset signal generation starting voltages :
 

PST520C	4.5V Typ.
PST520D	4.2V Typ.
PST520E	3.9V Typ.
PST520F	3.6V Typ.
PST520G	3.3V Typ.
PST520H	3.1V Typ.
- (5) Taping type is also available.

### 用途

- (1) バッテリバックアップされたメモリの制御回路。
- (2) 電源ON~OFF時の誤動作対策。
- (3) 電源の瞬断等によるシステム暴走対策。
- (4) パソコン、プリンタ、VTR、その他CPU搭載機器のリセット機能。

### APPLICATIONS

- (1) As control circuit of battery-backed memory.
- (2) As measure against erroneous operations at power ON-OFF.
- (3) As measure against system runaway at instaneous break of power supply etc.
- (4) As resetting function for the CPU-mounted equipment, such as personal computers, printers, VTRs and so forth.

### 外形図/DIMENSIONS

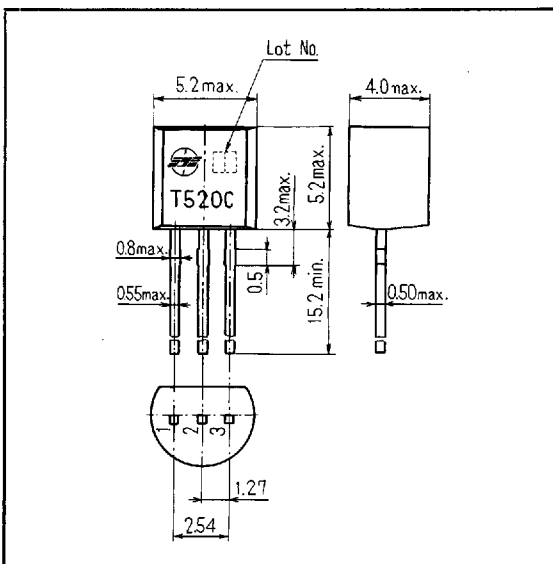

### 等価回路/EQUIVALENT CIRCUIT

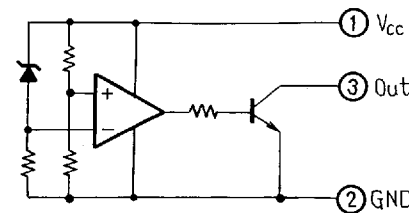



**MONOLITHIC IC**

■最大定格/MAXIMUM RATING

項目/Item	記号/Symbol	定格/Rating	単位/Unit
動作温度 Operating Temperature	Topr	-20~+75	°C
保存温度 Storage Temperature	Tstg	-30~+125	°C
消費電力 Power Dissipation	Pd	300	mW
電源電圧 Supply Voltage	Vcc	-0.3~+15	V

■電気的特性/ELECTRICAL CHARACTERISTICS of PST520

(Ta=25°C)

項目 Item	記号 Symbol	測定回路 Measuring Circuit	測定条件 Measuring Conditions	最小 Min.	標準 Typ.	最大 Max.	単位 Unit	
検出電圧 Detecting Voltage	Vs	1	RL=2.2kΩ VOL≤0.4V	PST520C	4.35	4.5	4.65	V
				PST520D	4.05	4.2	4.35	
				PST520E	3.75	3.9	4.05	
				PST520F	3.45	3.6	3.75	
				PST520G	3.15	3.3	3.45	
				PST520H	2.95	3.1	3.25	
ローレベル出力電圧 Low-Level Output Voltage	Vor.	1	RL=2.2kΩ Vcc=4.3V			0.4	V	
出力リーク電流 Output Leakage Current	IOH	1	Vcc=15V			0.1	μA	
ヒステリシス電圧 Hysteresis Voltage	ΔVs	1	RL=2.2kΩ	30	50	100	mV	
検出電圧温度係数 Detecting Voltage Temperature Coefficient	Vs/ΔT	1	RL=2.2kΩ		±0.01		%/°C	
ON時回路電流 Circuit Current at ON Time	IccL	1	Vcc=Vsmin. -0.05V			100	μA	
OFF時回路電流 Circuit Current at OFF Time	IccH	1	Vcc=5.25V			180	μA	
動作限界電圧 Threshold Operating Voltage	VopL	1	RL=22kΩ VOL≤0.4V		0.8	1.0	V	
"L"伝達遅延時間 "L" Transmission Delay Time	tpHL	2	RL=2.2kΩ CL=100pF Vcc=4.8V →4.0V		3		μS	
"H"伝達遅延時間 "H" Transmission Delay Time	tpLH	2	RL=2.2kΩ CL=100pF Vcc=4.0V →4.8V		8		μS	
ON時出力電流 I Output Current at ON Time I	IOI I		Vcc=Vsmin. -0.05V Tc=25°C	2.0			mA	
ON時出力電流 II Output Current at ON Time II	IOI II		Vcc=Vsmin. -0.05V Tc=-20~ +75°C	1.5			mA	

[注] 検出電圧以外はPST520Cの特性値を代表例として掲載しています。

[Note] Characteristics are the representative example of PST520C unless detecting voltage.



# モノリシック IC



## 測定回路/MEASURING CIRCUITS

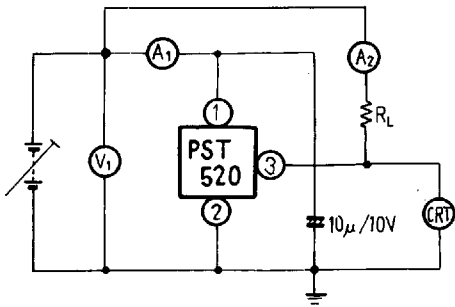

Note (1) A : 直流電流計/DC Ammeter  
 V : 直流電圧計/DC Voltmeter  
 CRT: オシロスコープ/Oscilloscope  
 (2) 入力パルス/ Input pulse

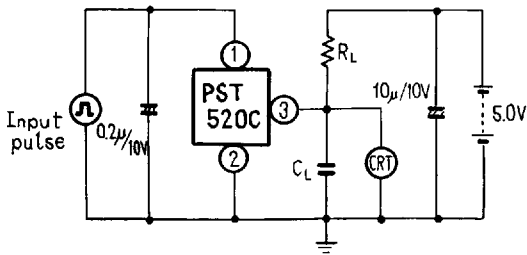
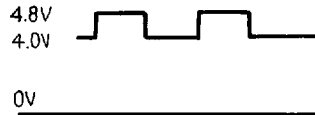

[注] 入力モデルは PST520C の例です。  
 [Note] Example is PST520C.

## 測定回路例/APPLIED CIRCUITS

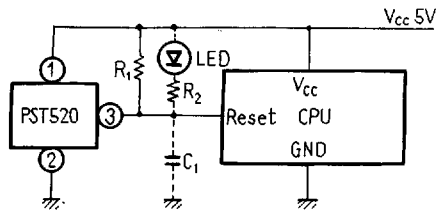

[注]  
 (1) LED R<sub>2</sub> を接続することにより、電圧低下インジケータとなります。  
 (2) C<sub>1</sub> を接続し、C<sub>1</sub>、R<sub>1</sub> による時定数をえらぶことによりパワーオンディレイタイムを設定できます。

[Note]  
 (1) Connecting of LED and R<sub>2</sub> obtains a voltage drop indicator.  
 (2) Connecting of C<sub>1</sub> and selection of time constant with C<sub>1</sub> and R<sub>1</sub> set the power-ON delay time.

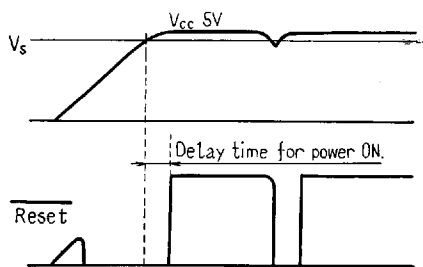



**MONOLITHIC IC**

■ 特性/CHARACTERISTICS

■ V<sub>cc</sub> vs. V<sub>out</sub>

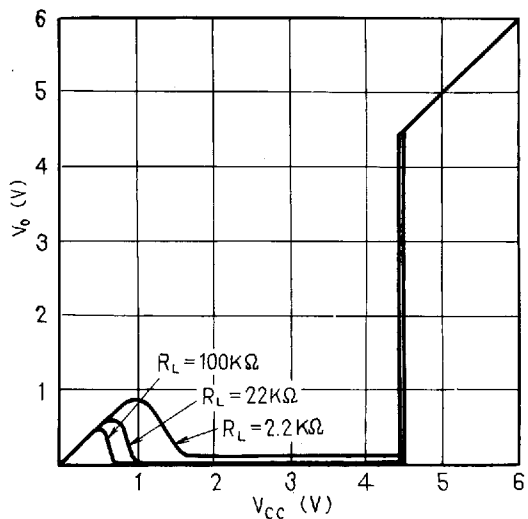

■ V<sub>cc</sub> vs. V<sub>out</sub>

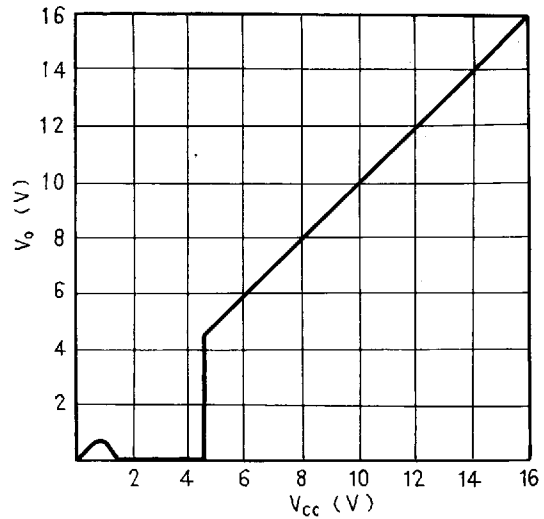

■ V<sub>cc</sub> vs. I<sub>cc</sub>

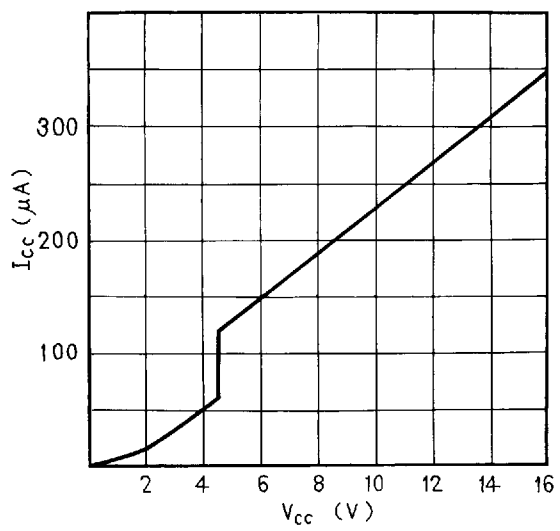

■ V<sub>s</sub> vs. Temp.

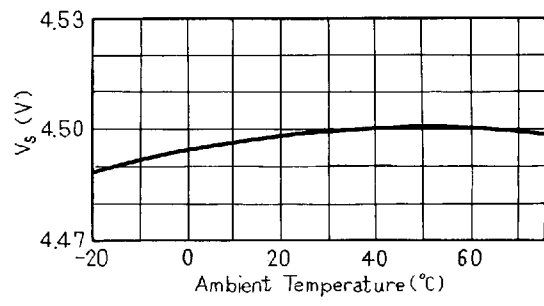

[注] 特性カーブは PST520C の特性を代表例として掲載しています。なお PST520D~PST520H は、検出電圧を除き同一です。  
 [Note] Characteristic is the representative example of PST520C. PST520D~H has same characteristics except detecting voltage.



モノリシック IC



遅延時間/Delay Time (ゲート IC との組合わせ/Combination with the gate IC)

